

V1

ESC 1:50

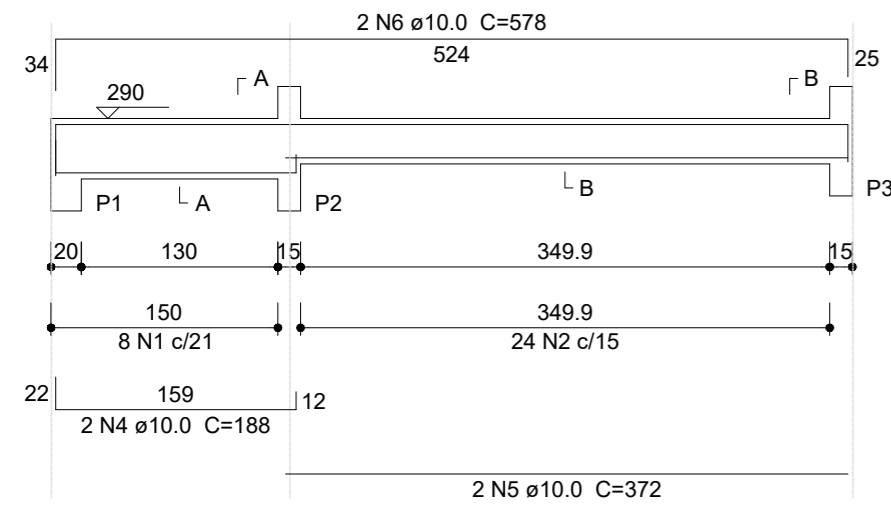

SEÇÃO A-A

ESC 1:25

SEÇÃO B-B

ESC 1:25

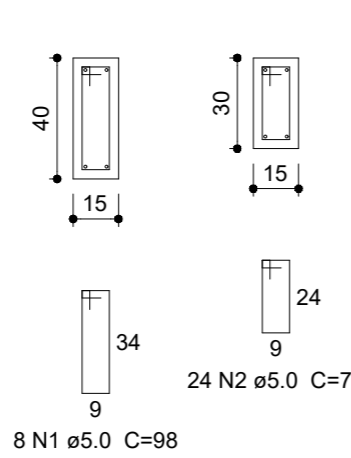

V2

ESC 1:50

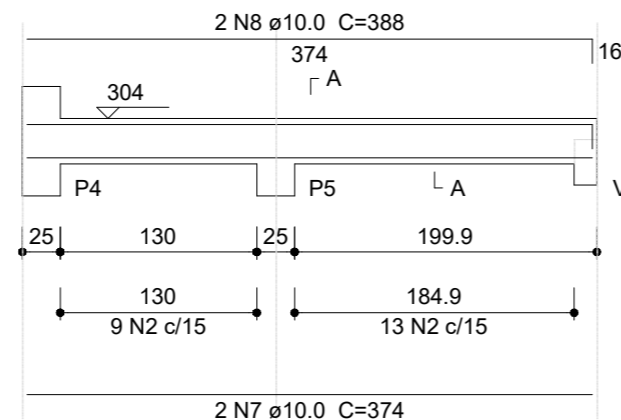

SEÇÃO A-A

ESC 1:25

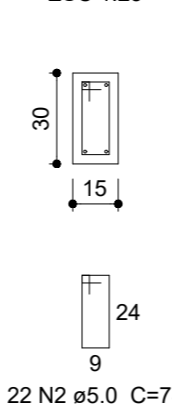

V3

ESC 1:50

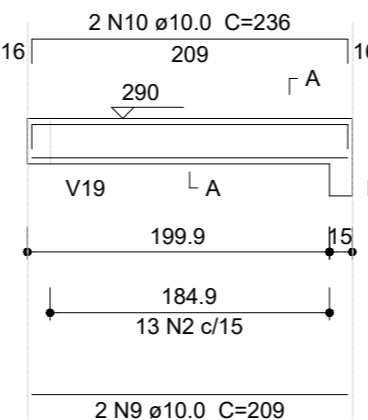

SEÇÃO A-A

ESC 1:25

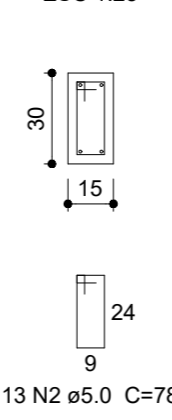

V4

ESC 1:50

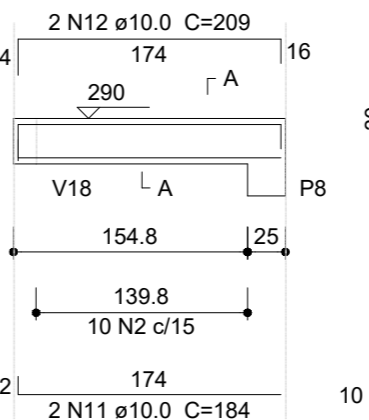

SEÇÃO A-A

ESC 1:25

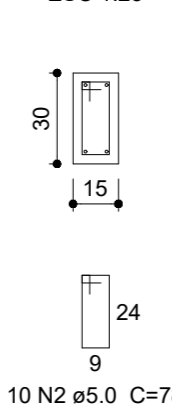

V6

ESC 1:50

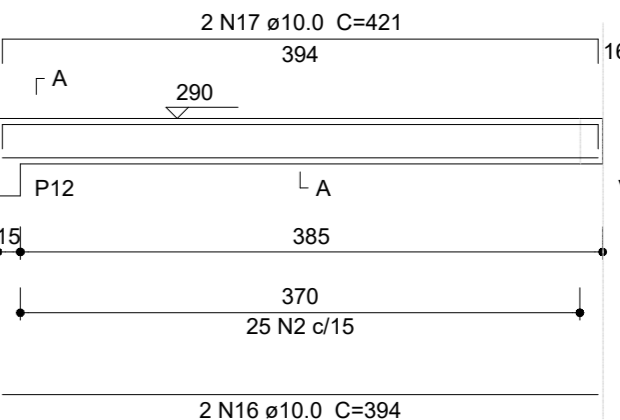

SEÇÃO A-A

ESC 1:25

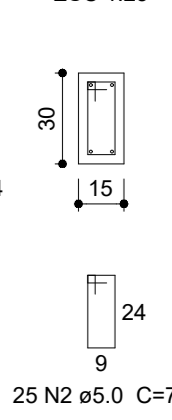

V5

ESC 1:50

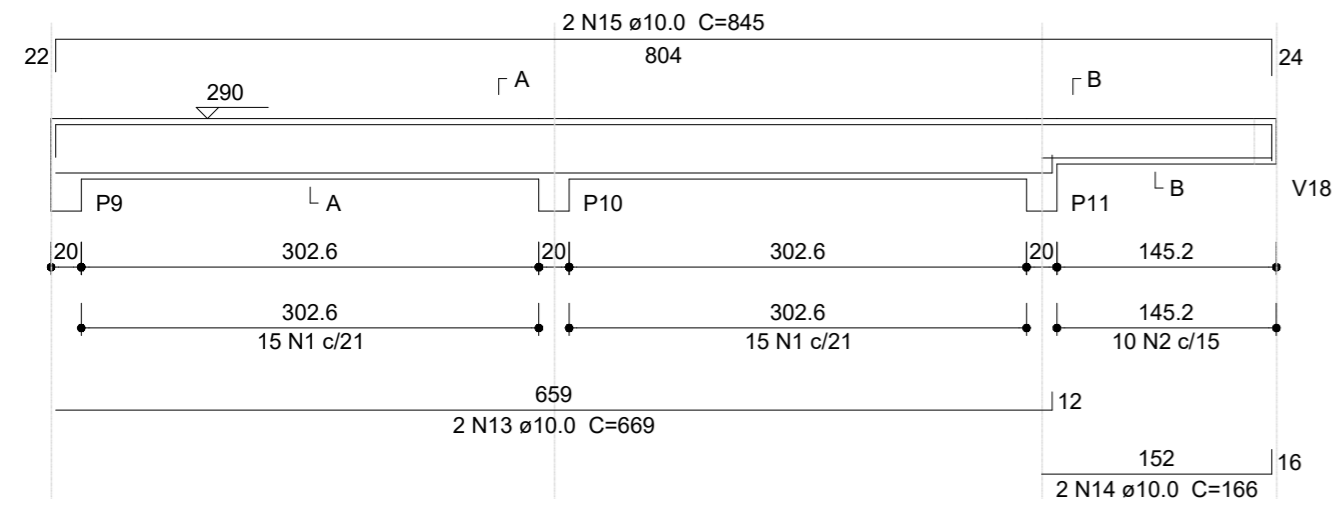

SEÇÃO A-A

ESC 1:25

SEÇÃO B-B

ESC 1:25

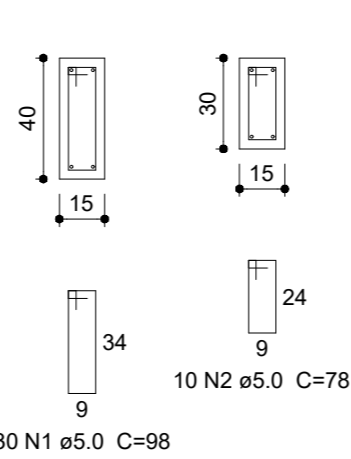

V7

ESC 1:50

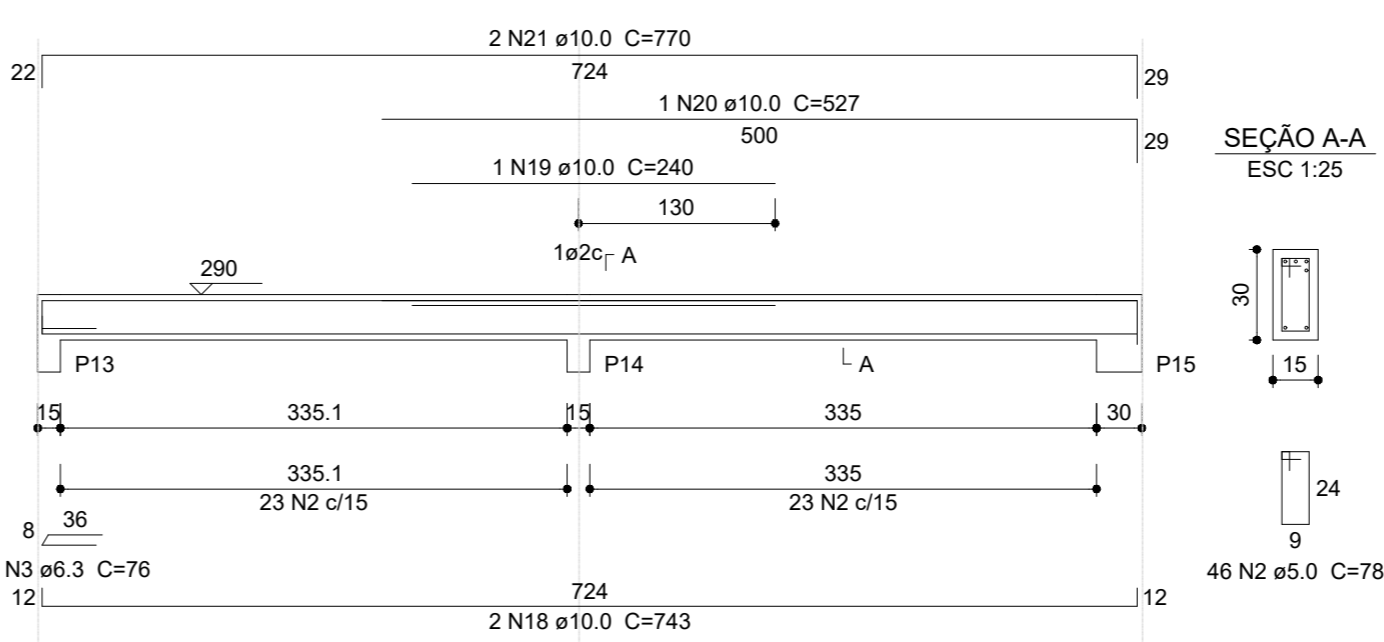

SEÇÃO A-A

ESC 1:25

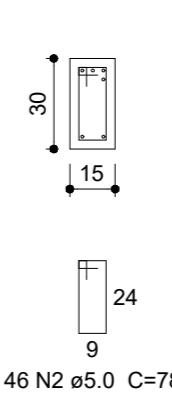

V8

ESC 1:50

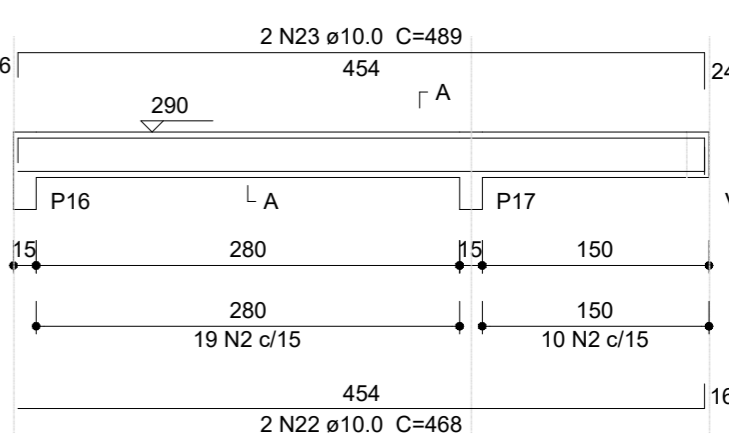

SEÇÃO A-A

ESC 1:25

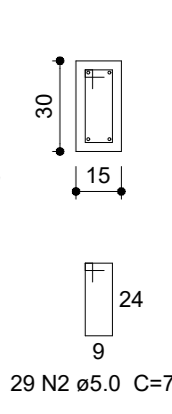

V9

ESC 1:50

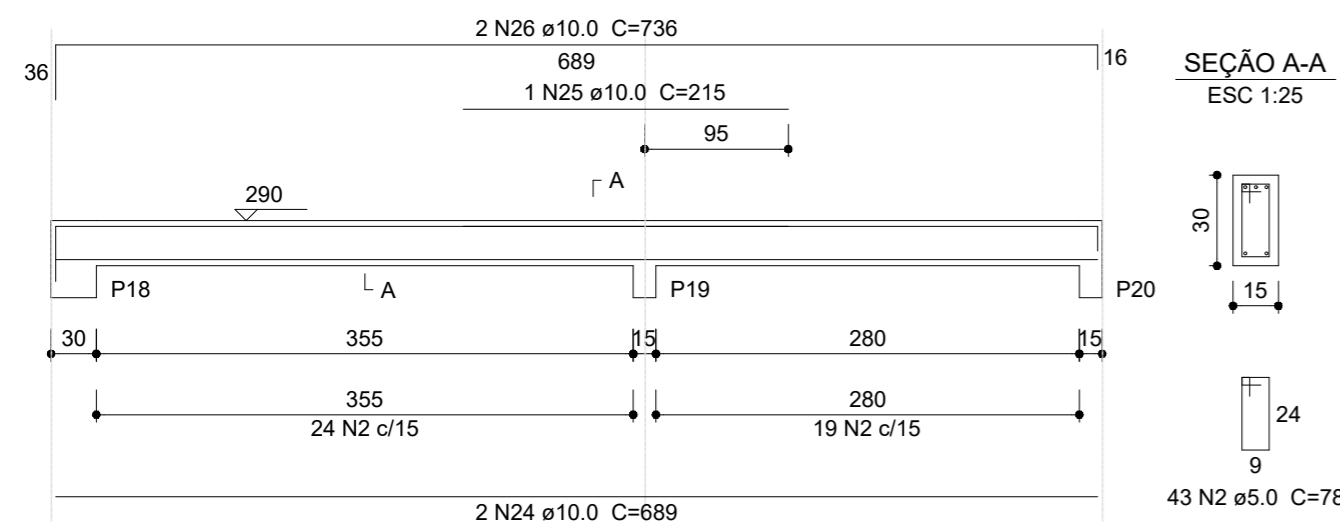

SEÇÃO A-A

ESC 1:25

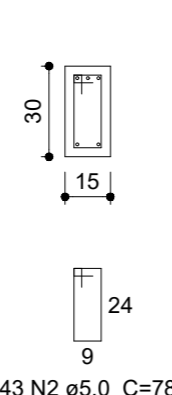

V10

ESC 1:50

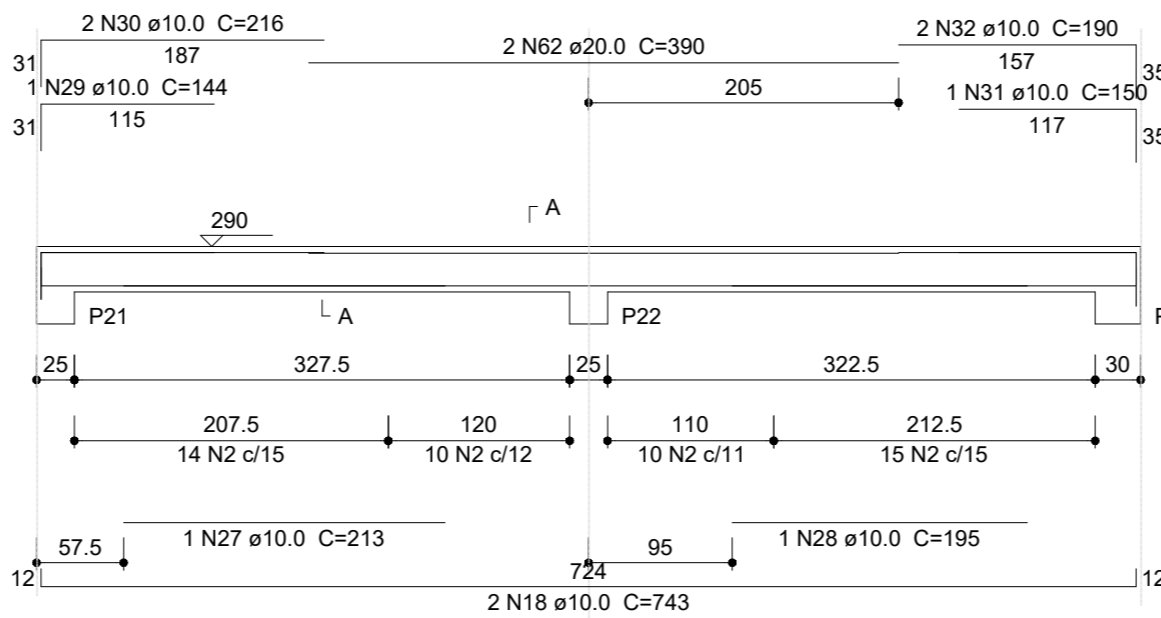

SEÇÃO A-A

ESC 1:25

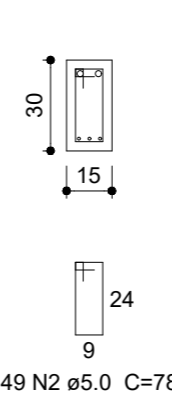

V11

ESC 1:50

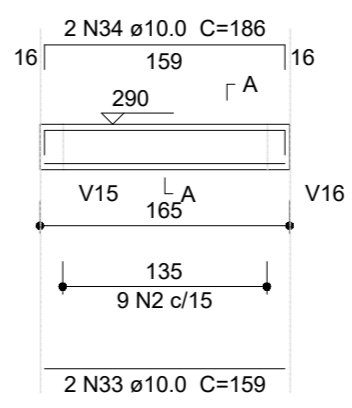

SEÇÃO A-A

ESC 1:25

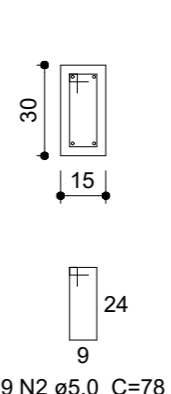

V13

ESC 1:50

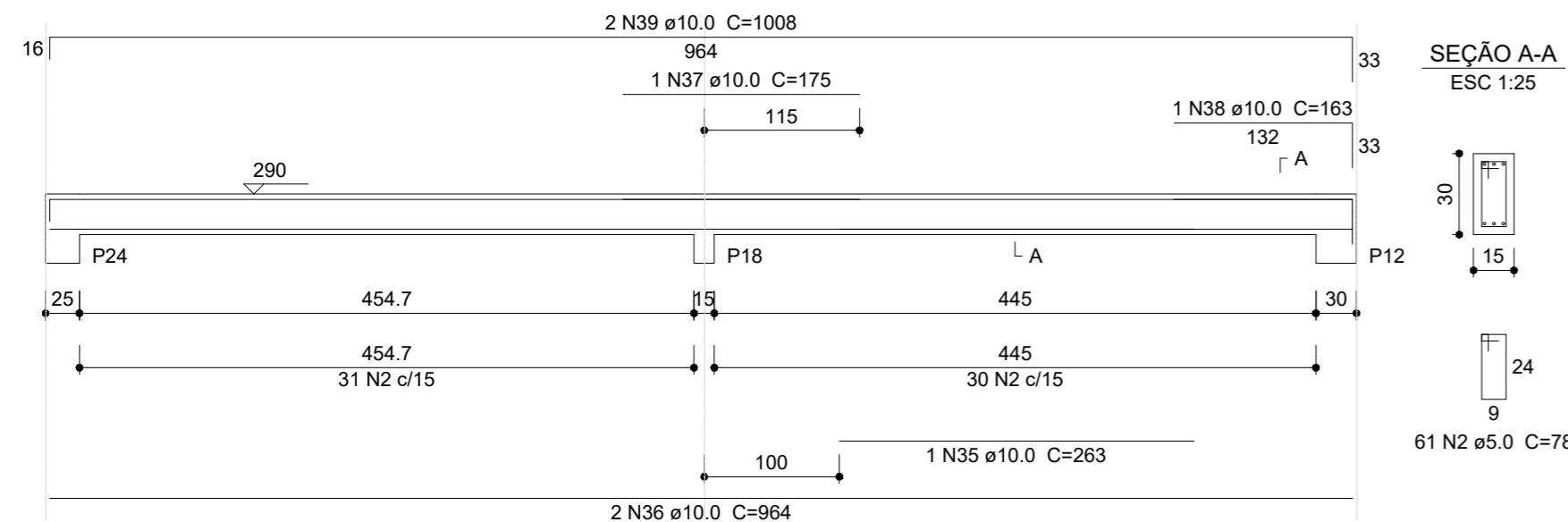

SEÇÃO A-A

ESC 1:25

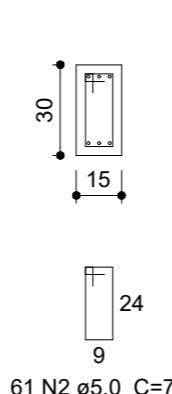

V19

ESC 1:50

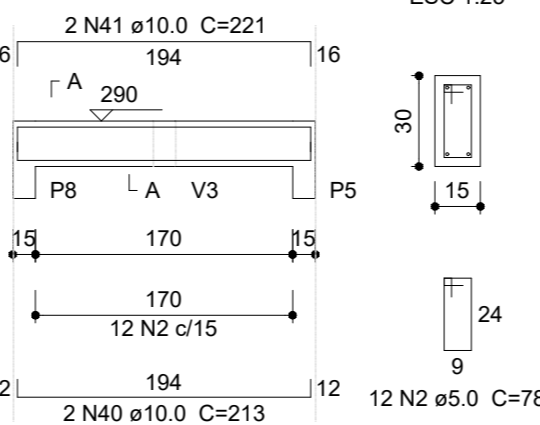

SEÇÃO A-A

ESC 1:25

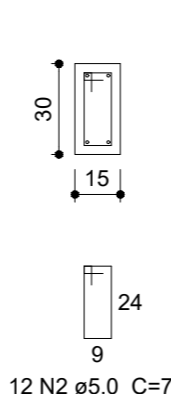

Resumo do aço

AÇO	DIAM (mm)	C.TOTAL (m)	PESO + 10 % (kg)
CA50	6.3	0.8	0.2
	10.0	564	382.5
	20.0	7.8	21.2
CA60	5.0	626.1	106.1
PESO TOTAL (kg)			
CA50		403.8	
CA60		106.1	

Volume de concreto (C-25) = 6 m³
Área de forma = 99.38 m²

REVISÃO	DESCRIÇÃO	DATA

OBRA/SERVIÇO: Estrutural - Detalhamento de Vigas - Cobertura

ENDEREÇO: Rodovia VRS 868, Taquari/RS

TÍTULO: Conclusão Ampliação EMEF Timóteo Junqueira dos Santos



PROPRIETÁRIO:
PREFEITURA DE TAQUARI

RESPONSÁVEL TÉCNICO PELO PROJETO ESTRUTURAL
SÉRGIO VINÍCIUS NOSCHANG - ENG. CIVIL - CREA RS152282

PRANCHA Nº:
EST
07/09

187,10 m²	1/50	Agosto/2023	0
ÁREA	ESCALA	DATA	REVISÃO